

Keysight N5193A

UXG Agile Signal Generator

10 MHz to 20 or 40 GHz

Data Sheet



Table of Contents

| | |
|---|----|
| Definitions and Conditions | 3 |
| Specifications | 4 |
| Frequency..... | 4 |
| Power..... | 7 |
| Switching speed..... | 11 |
| Synchronization..... | 13 |
| Normal mode..... | 14 |
| Fast CW mode..... | 14 |
| PDW streaming mode..... | 14 |
| List mode..... | 14 |
| Spectral purity..... | 15 |
| Phase noise..... | 16 |
| Pulse modulation (Option PM1)..... | 18 |
| Chirp and chirped-pulse modulation (Options UNT, WC1, and PM1)..... | 20 |
| Internal pulse generator (Option PM1)..... | 21 |
| Frequency modulation (Option UNT)..... | 21 |
| Phase modulation (Option UNT)..... | 22 |
| Amplitude modulation (Option UNT)..... | 22 |
| External modulation inputs (Option UNT)..... | 22 |
| Internal modulation source (Option UNT)..... | 23 |
| Simultaneous modulation..... | 23 |
| Remote programming..... | 23 |
| General specifications..... | 23 |
| Input/Output Descriptions | 24 |
| Front panel connectors..... | 24 |
| Rear panel connectors..... | 24 |
| Fast Control Port (FCP) interface modules..... | 25 |
| Performance Archive | 25 |
| Related Literature | 25 |

Definitions and Conditions

Specification (spec): represents warranted performance of a calibrated instrument that has been stored for a minimum of 2 hours within the operating temperature range of 0 to 55 °C, unless otherwise stated, and after a 1 hour warm-up period. The specifications include measurement uncertainty. Data represented in this document are specifications unless otherwise noted.

Typical (typ): describes additional product performance information that is not covered by the product warranty. It is performance beyond specifications that 80% of the units exhibit with a 95% confidence level at room temperature (approximately 25 °C). Typical performance does not include measurement uncertainty.

Nominal (nom): describes the expected mean or average performance, or an attribute whose performance is by design, such as the 50 Ω connector. This data is not warranted and is measured at room temperature (approximately 25 °C).

Measured (meas): describes an attribute measured during the design phase for purposes of communicating expected performance, such as amplitude drift vs. time. This data is not warranted and is measured at room temperature (approximately 25 °C).

All of the above apply when using the instrument in its default settings unless otherwise stated.

This data sheet provides a summary of the key performance parameters for UXG signal generators. All options referenced in this data sheet are described in the UXG configuration guide (5992-0093EN).

Unless otherwise noted, this data sheet applies to units with serial numbers ending with 5646xxxx or greater.

Specifications

Frequency

| Range | | |
|--|--|--------------------|
| | Specified range | Tunable range |
| Option 520 | 10 MHz to 20 GHz | 10 MHz to 21.5 GHz |
| Option 540 | 10 MHz to 40 GHz | 10 MHz to 40 GHz |
| CW frequency resolution | | |
| Standard | 10 kHz | |
| Option FR1 | 0.001 Hz | |
| Frequency switching modes | | |
| Phase continuous switching | Minimizes phase changes and spectral splatter when transitioning to a new frequency within a band. | |
| Phase coherent switching | When returning to a prior frequency, returns to the prior phase trajectory at that frequency, assuming the same setup conditions. Some temporary amplitude and phase changes may occur during transitions. | |
| Phase offset | | |
| | Adjustable in 0.1° increments (nom) | |
| Accuracy | | |
| | Accuracy is equivalent to the internal or external frequency reference in use. | |
| | Choices are the internal timebase reference oscillator, the external reference input, the system sync input, and the 6 GHz input. | |
| Internal timebase reference oscillator | | |
| Initial calibration accuracy | $\pm 5 \times 10^{-8}$ | |
| Aging rate ¹ | $\pm 3 \times 10^{-8}$ /year or $\pm 2.5 \times 10^{-10}$ /day after 30 days | |
| Temperature effects | $\pm 4.5 \times 10^{-9}$ (nom) from 0 to 55 °C | |
| Electronic frequency control (EFC) sensitivity | -0.04 ppm/V (nom) from -10 V to +10 V | |
| External 10 MHz reference input | | |
| Frequency | 10 MHz | |
| Modes | Manually or automatically selected | |
| Lock range | ± 1.0 ppm (nom) | |
| Input amplitude | 6 dBm \pm 6 dB (nom). To optimize phase noise use 6 dBm \pm 2 dB (nom). | |
| Input impedance | 50 Ω (nom) | |
| Other reference choices | | |
| System sync in/out | See the Synchronization Section | |
| 6 GHz in/out | See the Synchronization Section | |
| Reference output (10/100 MHz output) | | |
| Frequency | 10 MHz or 100 MHz, user selectable | |
| Amplitude | 7 dBm (nom) into 50 Ω load | |

1. Not verified by Keysight N7800A TME Calibration and Adjustment Software. Daily aging rate may be verified as a supplementary chargeable service, on request.

Frequency bands (Frequency Mode A, default)

Frequency Bands (Frequency Mode A, Default)

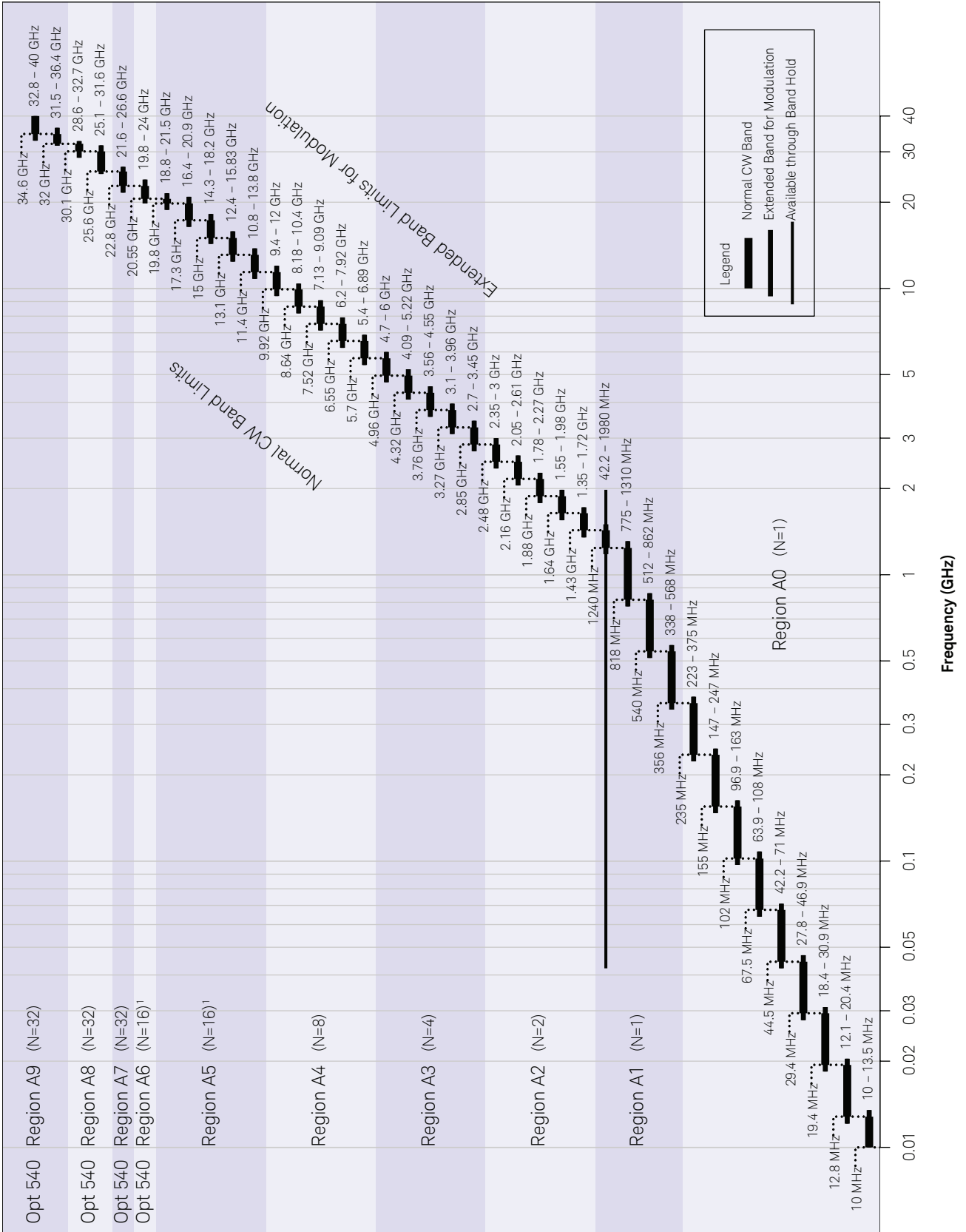

1. In Option 520, the 18.8-21.5 GHz band behaves like it is part of Region A5.
 In Option 540, the 18.8-21.5 GHz band behaves like it is part of Region A6.

Frequency bands (Frequency Mode B)

Frequency Bands (Frequency Mode B)

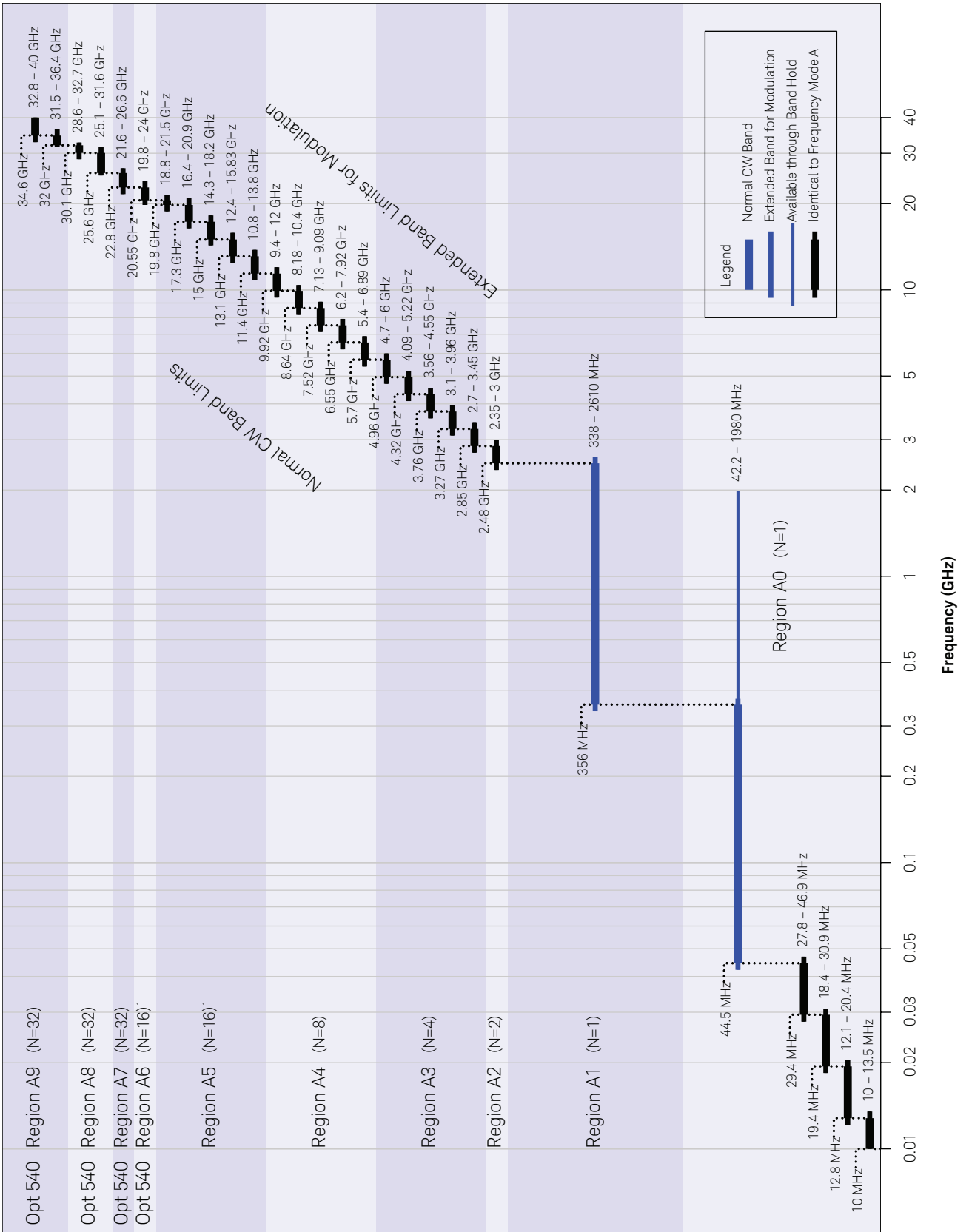

1. In Option 520, the 18.8-21.5 GHz band behaves like it is part of Region A5. In Option 540, the 18.8-21.5 GHz band behaves like it is part of Region A6.

Frequency band overview

| | |
|--------------------------------|---|
| Default bands (Mode A) | Provide lowest harmonics and spurious signals. |
| 42.2 to 1980 MHz band (Mode B) | Provides wider bandwidth at low frequencies for wider chirps, wider FM, and better pulse shape. |
| 338 to 2610 MHz band (Mode B) | Provides wider bandwidth at low frequencies for wider chirps, wider FM, and better pulse shape. Reduces pulse video feedthrough. |

Power

Dual attenuator specified frequency range (Option AT2)

| | Option 520 | Option 540 |
|-----------------------------|------------------|------------------|
| Electronic agile attenuator | 10 MHz to 20 GHz | 10 MHz to 40 GHz |
| Mechanical step attenuator | 10 MHz to 20 GHz | 10 MHz to 40 GHz |

Dual attenuator step size (Option AT2)

| | |
|-----------------------------|--|
| Electronic agile attenuator | 0 dB to 65 dB in 5 dB steps, for frequencies up to 40 GHz, or bypassed |
| Mechanical step attenuator | 0 dB to 85 dB in 5 dB steps, for frequencies up to 40 GHz |

Maximum output power (Option 520)

| Frequency | Standard | Option AT2 Electronic attenuator bypassed | Option AT2 ¹ Electronic attenuator inline |
|--------------------|----------|--|---|
| 10 MHz to 13 GHz | 10 dBm | 10 dBm | -1 dBm |
| > 13 GHz to 18 GHz | 10 dBm | 10 dBm | -4 dBm |
| > 18 GHz to 20 GHz | 10 dBm | 10 dBm | -6 dBm |

Maximum output power (Option 540)

| Frequency | Standard | Option AT2 Electronic attenuator bypassed | Option AT2 ¹ Electronic attenuator inline |
|---------------------------|----------|--|---|
| 10 MHz to 13 GHz | 10 dBm | 8 dBm | -3 dBm |
| > 13 GHz to 18 GHz | 10 dBm | 8 dBm | -5 dBm |
| > 18 GHz to 20.55 GHz | 7 dBm | 6 dBm | -10 dBm |
| > 20.55 GHz to < 25.6 GHz | 10 dBm | 10 dBm | -7 dBm |
| 25.6 GHz to 32 GHz | 7 dBm | 6 dBm | -8 dBm |
| > 32 GHz to 40 GHz | 7 dBm | 7 dBm | -7 dBm |

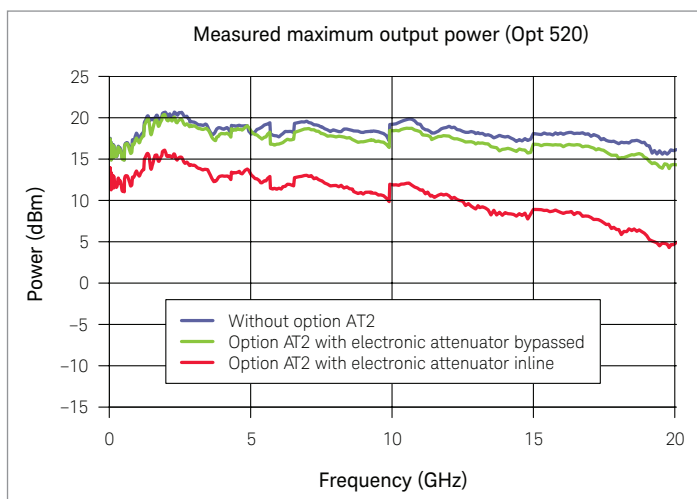

1. Note that during EW simulations using option AT2 agile power capability, these are the maximum power values available in the agile power range. Bypass mode is not recommended for EW simulations that require > 20 dB agile power capability, as the mechanical switches used to switch between bypass and inline modes can take as long as 20 ms (nom) to change modes.

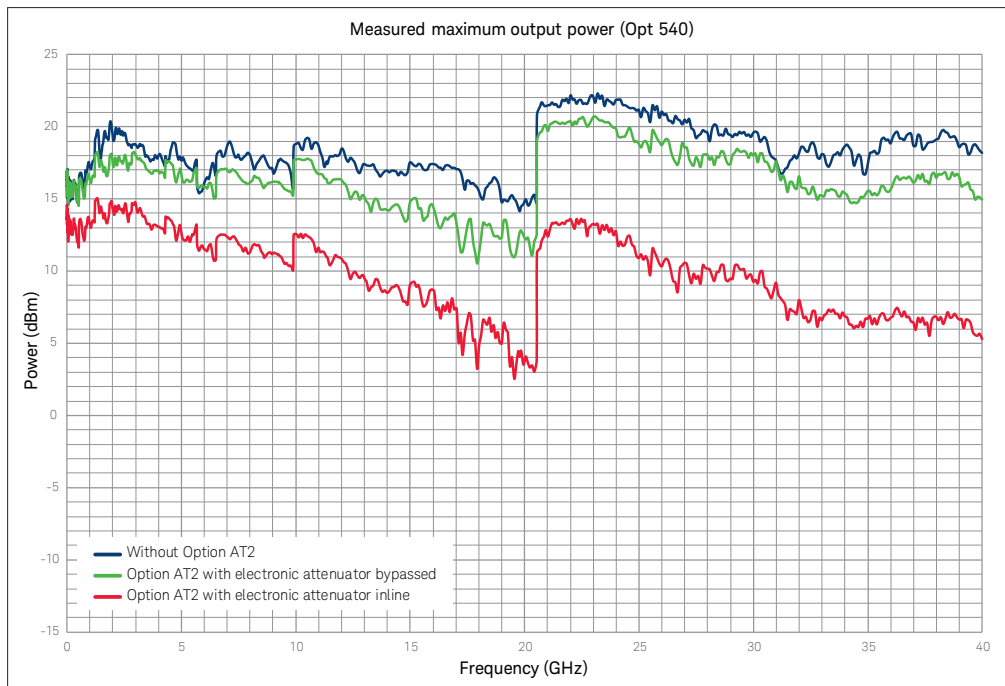

| Minimum settable output power | | | |
|---|---|---|---|
| Frequency | Standard | Option AT2 Electronic attenuator bypassed | Option AT2 Electronic attenuator inline |
| 10 MHz to 20 GHz | -10 dBm | -95 dBm | -130 dBm |
| > 20 GHz to 40 GHz (Option 540) | -10 dBm | -95 dBm | -130 dBm |
| Agile power range | | | |
| Frequency | Standard | Option AT2 Electronic attenuator bypassed | Option AT2 Electronic attenuator inline |
| Option 520 | | | |
| 10 Hz to 20 GHz | 20 dB (nom) | 20 dB (nom) | 90 dB (nom) |
| Option 540 | | | |
| 10 Hz to 18 GHz | 20 dB (nom) | 20 dB (nom) | 90 dB (nom) |
| > 18 to 20.55 GHz | 17 dB (nom) | 20 dB (nom) | 90 dB (nom) |
| > 20.55 to < 25.6 GHz | 20 dB (nom) | 10 dB (nom) | 80 dB (nom) |
| 25.6 GHz to 40 GHz | 17 dB (nom) | 10 dB (nom) | 80 dB (nom) |
| Leveling modes | | | |
| ALC on | Internal power leveling | | |
| ALC off ¹ | No power leveling | | |
| ALC off with power alignment | Power alignment is a routine that improves level accuracy with ALC off. It aligns the power level with ALC off to match the power level with ALC on at a customer specified power level. It should be run at regular intervals and whenever the operating temperature changes $\pm 5^\circ\text{C}$ from the alignment temperature. | | |
| RF Gating | | | |
| Turns RF power on/off with external trigger | | | |

1. For EW simulations using option AT2 agile power capability, it is strongly recommended to operate with ALC mode off after running power alignment. If ALC mode is left on, switching speed performance will be significantly reduced.

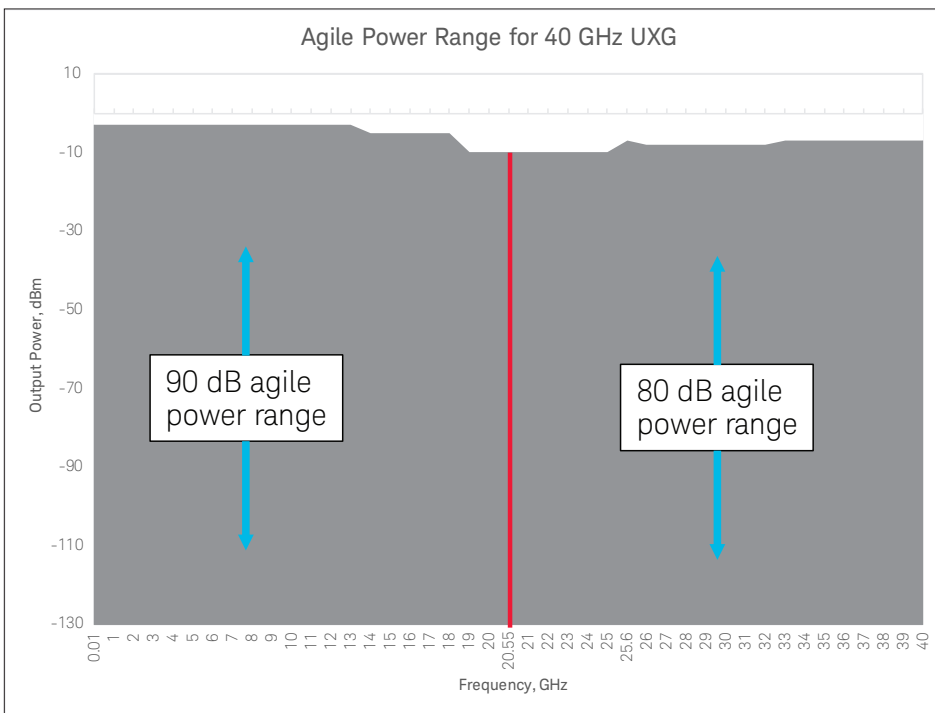
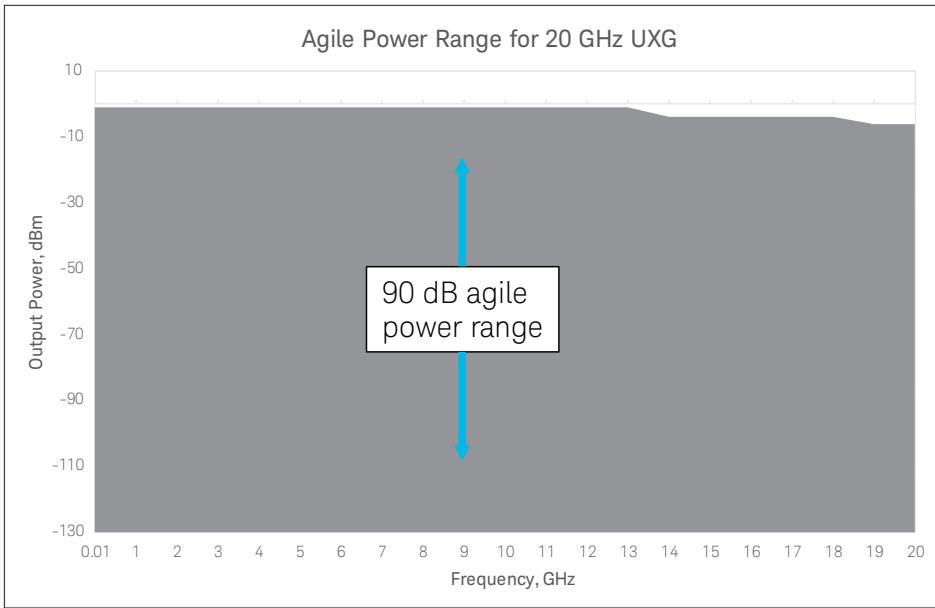

Amplitude resolution

0.01 dB

Level accuracy (Option 520)¹

Specifications apply for CW signals that do not exceed the maximum specified power. For instruments with Option 1ED Type-N connectors, specifications apply below 18 GHz and performance is typically degraded 0.2 dB above 18 GHz.

| Output power (Standard) | | ALC on | ALC off^{2,3} | |
|----------------------------------|------------------------------|------------------------------|------------------------------|------------------------------|
| 10 dBm to 0 dBm | | ± 1.4 dB (typ) | ± 2.0 dB (typ) | |
| Output power (Option AT2) | Mechanical attenuator | Electronic attenuator | ALC on | ALC off^{2,3} |
| 10 to 2 dBm | 0 dB | Bypass | ± 1.5 dB | ± 2.0 dB |
| < 2 to -10 dBm | 0 dB | Bypass | ± 1.6 dB (typ) | ± 2.5 dB (typ) |
| 10 to -75 dBm | Auto | Bypass | ± 1.5 dB | ± 2.0 dB |
| -3 to -65 dBm | 0 dB | Inline | ± 1.5 dB | ± 2.0 dB ⁴ |
| < -65 to -90 dBm | 0 dB | Inline | ± 2.0 dB | ± 2.5 dB ⁴ |
| 5 to -10 dBm | Auto | Auto | ± 1.5 dB | ± 2.0 dB ⁴ |
| < -10 to -80 dBm | Auto | Auto | ± 1.6 dB | ± 2.5 dB ⁴ |

Level accuracy (Option 540, frequency ≤ 20 GHz)¹

Specifications apply for CW signals that do not exceed the maximum specified power.

| Output power (Standard) | | ALC on | ALC off^{2,3} | |
|----------------------------------|------------------------------|------------------------------|------------------------------|------------------------------|
| 10 dBm to 0 dBm | | ± 1.4 dB (typ) | ± 2.0 dB (typ) | |
| Output power (Option AT2) | Mechanical attenuator | Electronic attenuator | ALC on | ALC off^{2,3} |
| 10 to 0 dBm | 0 dB | Bypass | ± 1.5 dB | ± 2.0 dB |
| < 0 to -10 dBm | 0 dB | Bypass | ± 1.6 dB (typ) | ± 2.5 dB (typ) |
| 10 to -75 dBm | Auto | Bypass | ± 1.5 dB | ± 2.0 dB |
| -15 to -65 dBm | 0 dB | Inline | ± 1.5 dB | ± 2.0 dB ⁴ |
| < -65 to -90 dBm | 0 dB | Inline | ± 2.0 dB | ± 2.5 dB ⁴ |
| 5 to -10 dBm | Auto | Auto | ± 1.5 dB | ± 2.0 dB ⁴ |
| < -10 to -80 dBm | Auto | Auto | ± 1.6 dB | ± 2.5 dB ⁴ |

Level accuracy (Option 540, frequency > 20 GHz)

Specifications apply for CW signals that do not exceed the maximum specified power.

| Output power (Standard) | | ALC on | ALC off^{2,3} | |
|----------------------------------|------------------------------|------------------------------|------------------------------|------------------------------|
| 10 dBm to 0 dBm | | ± 1.4 dB (typ) | ± 4.5 dB (typ) | |
| Output power (Option AT2) | Mechanical attenuator | Electronic attenuator | ALC on | ALC off^{2,3} |
| 10 to 0 dBm | 0 dB | Bypass | ± 1.8 dB | ± 4.5 dB |
| < 0 to -10 dBm | 0 dB | Bypass | ± 1.6 dB (typ) | ± 5.0 dB (typ) |
| 10 to -50 dBm | Auto | Bypass | ± 1.8 dB | ± 4.5 dB |
| < -50 to -75 dBm | Auto | Bypass | ± 2.2 dB | ± 4.5 dB |
| -15 to -65 dBm | 0 dB | Inline | ± 2.0 dB | ± 4.5 dB |
| 5 to -10 dBm | Auto | Auto | ± 2.0 dB | ± 4.5 dB |
| < -10 to -80 dBm | Auto | Auto | ± 2.6 dB | ± 4.5 dB |

Agile power linearity (frequency ≤ 20 GHz with Option AT2)³

Measured relative to -5 dBm for Option 520 and relative to -15 dBm for Option 540 with the mechanical step attenuator set to 0 dB and the electronic attenuator inline.

| | |
|--------------------|--|
| 10 MHz to 13 GHz | ± 0.4 dB (typ) for relative power from 0 to -75 dB |
| > 13 GHz to 20 GHz | ± 0.5 dB (typ) for relative power from 0 to -75 dB |

Agile power linearity (frequency > 20 GHz with Options 540 and AT2)³

Measured relative to -15 dBm with the mechanical step attenuator set to 0 dB and the electronic attenuator inline.

| | |
|--------------------|--|
| > 20 GHz to 40 GHz | ± 1.8 dB (typ) for relative power from 0 to -60 dB ± 2.2 dB (typ) for relative power from -60 to -65 dB |
|--------------------|--|

- Specifications shown represent uncorrected performance at the RF output port. Level accuracy at the DUT input can be significantly improved by running the UXG user amplitude correction routine with a power sensor.
- Specifications apply after running power alignment at +4 dBm power level. It is strongly recommended that EW simulations be performed with ALC mode off after running power alignment. If ALC mode is left on, switching speed performance will be significantly reduced.
- The Power Alignment routine aligns ALC off level accuracy performance to ALC ON performance at a customer specified power. It should be run at regular intervals, and whenever the operating temperature changes ±5 °C from the alignment temperature. For optimal performance in applications where the instrument will be used at more than one power level, execute power alignment at a power level < 5 dBm and with the output attenuation set to the desired operating condition.
- For frequencies > 17 to 20 GHz, level accuracy degrades by an additional 0.5 dB.

Temperature stabilityALC on and frequency \leq 20 GHz \pm 0.02 dB/°C (typ)ALC on and frequency $>$ 20 GHz \pm 0.04 dB/°C (typ)ALC off and frequency \leq 20 GHz \pm 0.07 dB/°C (typ)ALC off and frequency $>$ 20 GHz \pm 0.15 dB/°C (typ)**Output impedance**50 Ω (nom)**SWR (meas) without Option AT2**

| Frequency | Option 520 with 1ED | Option 540 |
|----------------------|---------------------|------------|
| 10 MHz to 1 GHz | 1.4 : 1 | 1.4 : 1 |
| $>$ 1 GHz to 2 GHz | 1.4 : 1 | 1.5 : 1 |
| $>$ 2 GHz to 18 GHz | 1.7 : 1 | 2 : 1 |
| $>$ 18 GHz to 20 GHz | 1.9 : 1 | 2 : 1 |
| $>$ 20 GHz to 40 GHz | n/a | 3 : 1 |

SWR (meas) with Option AT2, electronic attenuator bypassed, mechanical attenuator = 0 dB

| Frequency | Option 520 without 1ED | Option 520 with 1ED | Option 540 |
|----------------------|------------------------|---------------------|------------|
| 10 MHz to 1 GHz | 1.4 : 1 | 1.4 : 1 | 1.4 : 1 |
| $>$ 1 GHz to 2 GHz | 1.4 : 1 | 1.4 : 1 | 1.5 : 1 |
| $>$ 2 GHz to 18 GHz | 1.7 : 1 | 1.7 : 1 | 2 : 1 |
| $>$ 18 GHz to 20 GHz | 1.8 : 1 | 1.8 : 1 | 2 : 1 |
| $>$ 20 GHz to 40 GHz | n/a | n/a | 2 : 1 |

SWR (meas) with Option AT2, electronic attenuator bypassed, mechanical attenuator $>$ 0 dB

| Frequency | Option 520 without 1ED | Option 520 with 1ED | Option 540 |
|----------------------|------------------------|---------------------|------------|
| 10 MHz to 1 GHz | 1.2 : 1 | 1.2 : 1 | 1.2 : 1 |
| $>$ 1 GHz to 2 GHz | 1.2 : 1 | 1.2 : 1 | 1.2 : 1 |
| $>$ 2 GHz to 18 GHz | 1.5 : 1 | 1.5 : 1 | 1.4 : 1 |
| $>$ 18 GHz to 20 GHz | 1.5 : 1 | 1.5 : 1 | 1.4 : 1 |
| $>$ 20 GHz to 40 GHz | n/a | n/a | 1.5 : 1 |

SWR (meas) with Option AT2, electronic attenuator inline

| Frequency | Option 520 without 1ED | Option 520 with 1ED | Option 540 |
|----------------------|------------------------|---------------------|------------|
| 10 MHz to 1 GHz | 1.6 : 1 | 1.6 : 1 | 1.6 : 1 |
| $>$ 1 GHz to 2 GHz | 1.5 : 1 | 1.5 : 1 | 1.5 : 1 |
| $>$ 2 GHz to 18 GHz | 1.7 : 1 | 1.7 : 1 | 1.7 : 1 |
| $>$ 18 GHz to 20 GHz | 1.7 : 1 | 1.7 : 1 | 1.7 : 1 |
| $>$ 20 GHz to 40 GHz | n/a | n/a | 1.8 : 1 |

Maximum reverse power

1/2 Watt, 0 VDC

User corrections

The User Corrections capability can apply corrections across frequency for amplitude, phase and time. Corrections can only be applied when the UXG operates in Streaming Mode. Amplitude-only corrections can be done with a power sensor. In order to maximize agile dynamic range, it may necessary to modify mechanical attenuator settings depending on PDW amplitude values and the peak amplitude loss being corrected.

Number of points/table 2 to 3201

Number of tables Dependent on available free memory in instrument; 10,000 maximum

Entry modes USB/LAN direct power meter control, LAN to GPIB and USB to GPIB, remote bus, and manual USB/GPIB power meter control

Switching speed

| Agile switching modes | |
|------------------------|--|
| Fast CW Switching Mode | The fast control port (Options CC1, CC2, or CC3) provides agile switching of CW frequency at a constant amplitude with the lowest latency. |
| Normal Mode | The fast control port (Option CC1 or CC3) provides agile switching of frequency, phase, amplitude, pulse modulation, frequency modulation, phase modulation, and chirp. Option CC2 provides agile switching of frequency only. |
| List Mode | Internal list memory and a hardware trigger provide agile switching of frequency, phase, amplitude, pulse modulation, frequency modulation, phase modulation, and chirp. |
| Streaming Mode | The LAN interface or fast control port (Option CC1 or CC3) provides agile switching of frequency, phase, amplitude, pulse modulation, frequency modulation, phase modulation and chirp. |

| Frequency transition types | | Transition examples |
|----------------------------|--|---|
| Type 1 | A frequency change in which the initial frequency and final frequency are in the same band per the frequency band diagrams in the frequency section, but not in region A0. | 3.77 GHz to 4.3 GHz 35 GHz to 39 GHz |
| Type 2 | A frequency change in which the initial frequency and final frequency are in the same region per the frequency band diagrams in the frequency section, but not in region A0. | 1 GHz (A1) to 500 MHz (A1) 34 GHz (A9) to 40 GHz (A9) |
| Type 3 | A frequency change in which the initial frequency and final frequency are in regions A1 through A5 per the frequency band diagrams in the frequency section. | 1 GHz (A1) to 18 GHz (A5) 10 GHz (A4) to 3 GHz (A2) |
| Type 4 | A frequency change in which the initial frequency and final frequency are in regions A1 through A9 per the frequency band diagrams in the frequency section. | 1 GHz (A1) to 37 GHz (A9) 28 GHz (A8) to 10 GHz (A4) 22 GHz (A6) to 39 GHz (A9) |

RF transition speed

For frequency and phase transitions at a fixed power level, with ALC off and the electronic attenuator bypassed, for frequencies < 32 GHz. Measured from the first phase change of more than 0.1 radians that occurs after the input trigger, and measured to RF phase settled. Applies to Normal, Streaming, or List Mode, not Fast CW Switching Mode.

| Transition type | Standard | Option SS1 | Option SS4 |
|-----------------|-------------------|-----------------|-------------|
| Type 1 | 100 μ s (typ) | 1 μ s (typ) | 50 ns (typ) |

Switching speed for Normal, Streaming, or List Mode

Update rate - Determined by transition time as measured from pulse sync out or list point start to RF phase and amplitude settled with ALC off. With Option AT2, includes amplitude changes over the agile power range.

| Transition type | Standard | Option SS1 | Option SS4 |
|-----------------|-------------|-------------------------|-------------|
| Type 1, 2, or 3 | 100 μ s | 1 μ s | 180 ns |
| Type 4 | 100 μ s | 31 μ s ¹ | 2.7 μ s |

Latency - measured from input trigger to RF phase and amplitude settled with ALC off. With Option AT2, includes amplitude changes over the agile power range.

| Transition type | Standard | Option SS1 | Option SS4 |
|-----------------|-------------|-------------------------|-------------|
| Type 1, 2 or 3 | 100 μ s | 1.5 μ s | 650 ns |
| Type 4 | 100 μ s | 31 μ s ¹ | 3.2 μ s |

CW switching speed for Fast CW Switching Mode

Update rate - Determined by transition time as measured from pulse sync out to RF phase and amplitude settled at a fixed power level with ALC off.

| Transition type | Standard | Option SS1 | Option SS4 |
|-----------------|-------------|-------------------------|-------------|
| Type 1, 2 or 3 | 100 μ s | 1 μ s | 240 ns |
| Type 4 | 100 μ s | 31 μ s ¹ | 2.7 μ s |

Latency - measured from input trigger to RF phase and amplitude settled at a fixed power level with ALC off.

| Transition type | Standard | Option SS1 | Option SS4 |
|-----------------|-------------|-------------------------|-------------|
| Type 1, 2 or 3 | 100 μ s | 1 μ s | 370 ns |
| Type 4 | 100 μ s | 31 μ s ¹ | 2.9 μ s |

1. For units with s/n 5646xxxx or greater, typical option SS1 type 4 switching speed is 4 μ s.

Additional contributors to switching speed

| | |
|--------------------------------|---|
| With GPIB, LAN, or USB control | Add 900 μ s (nom) from receipt of SCPI command or trigger signal |
| With Opt AT2 attenuators | Add 20 ms (nom) for any change in the mechanical attenuator or bypass switch. These are controllable via GPIB, LAN, or USB. These are not controllable via list or fast control port (Option CC1, CC2, or CC3). |
| For frequencies in Region A0 | Add 1 μ s (nom) when switching to or from any frequency in Region A0. |

Switching Speed Definitions Triggered Pulse

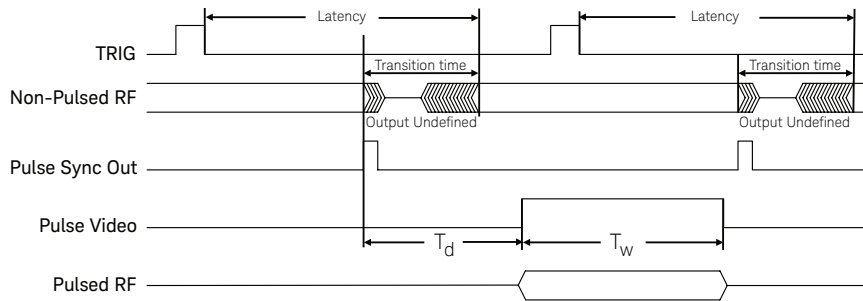

Switching Speed Definitions List Pulse

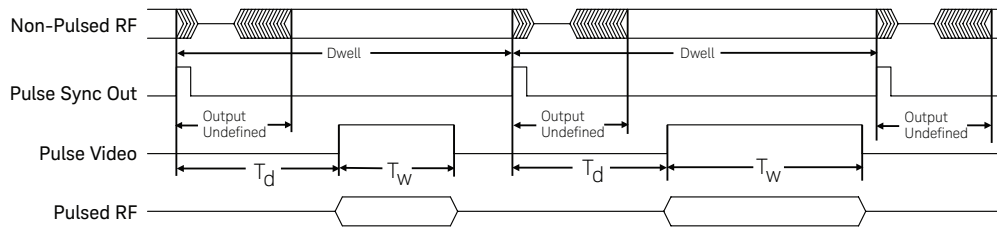

RF phase settling criteria

Final frequency

| | |
|-----------------------|--|
| 10 MHz to 8.6 GHz | Measured to phase settled within 0.1 radians of final phase. |
| > 8.6 GHz to 17.3 GHz | Measured to phase settled within 0.2 radians of final phase. |
| > 17.3 GHz | Measured to phase settled within 0.3 radians of final phase. |

RF amplitude settling criteria

Measured to amplitude settled within 1 dB of final amplitude.

Synchronization

Multiple UXG units can be synchronized together to have phase coherent outputs. This is useful for simulating angle-of-arrival (AoA) and phased array antenna wavefronts.

Synchronization input connections

| | |
|-------------------|---|
| 10 MHz input | Accepts a basic external reference at 10 MHz. Achieves lower residual phase noise than a 10 MHz input at the system sync input. See the Rear Panel Connectors Section for connection details. |
| System sync input | Recommended external reference input for use in system environments where trigger jitter and phase stability are important. Accepts a wide variety of input frequencies. See the Rear Panel Connectors Section for connection details. |
| 6 GHz input | Provides high stability synchronization between multiple signal generators. This is not a general 6 GHz connection. Only the 6 GHz synchronization output from another compatible signal generator should be connected. See the Rear Panel Connectors Section for connection details. |

Synchronization output connections

| | |
|--------------------|---|
| 10/100 MHz output | Provides a basic external reference at 10 MHz or 100 MHz. Achieves better spectral purity than the system sync output. See the Rear Panel Connectors Section for connection details. |
| System sync output | Recommended external reference output for use in system environments where trigger jitter and phase stability are important. Normally provides a 250 MHz output, but other frequencies are available. See the Rear Panel Connectors Section for connection details. |
| 6 GHz output | Provides high phase stability synchronization between multiple signal generators. See the Rear Panel Connectors Section for connection details. |

System sync input

| | |
|-----------------|--|
| Frequency | 1 to 250 MHz in 1 MHz steps. Default value is 250 MHz. |
| Lock range | ± 1.0 ppm (nom) |
| Amplitude | 6 dBm \pm 6 dB (nom). To optimize phase noise use 6 dBm \pm 2 dB (nom) |
| Input impedance | 50 Ω (nom) |
| Usage | The input frequency is not auto-detected. It must be entered manually and must be accurate to within the lock range above. |

System sync output

| | |
|------------------|--|
| Frequency | 10 MHz, 100 MHz, or 250 MHz, selectable. Multi-box synchronization overrides this selection and may use other frequencies. |
| Amplitude | 12 dBm (nom) |
| Output impedance | 50 Ω (nom) |

6 GHz input

| | |
|-----------------|---|
| Frequency | 6 GHz |
| Lock range | ± 1.0 ppm (nom) |
| Amplitude | 11 dBm \pm 6 dB (nom) |
| Input impedance | 50 Ω (nom) |
| Usage | This input must be connected to the 6 GHz output (described below) or a similar output from another compatible signal generator. The signal generator will not function without a 6 GHz signal at this input. |

6 GHz output

| | |
|------------------|---|
| Frequency | 6 GHz |
| Amplitude | 17 dBm (nom) |
| Output impedance | 50 Ω (nom) |
| Usage | A rigid jumper cable is provided to connect the 6 GHz output to the 6 GHz input. The jumper can be removed to distribute this signal to other equipment. When distributing this signal to multiple UXG signal generators, approximately 12 dB of loss is permissible before distribution amplifiers are required. One of the distributed outputs from a master signal generator must be connected back into the 6 GHz input of the master signal generator. |

Reference bandwidth

| | |
|------------|---|
| Standard | 25 Hz |
| Option EP1 | 25 Hz, 75 Hz, 400 Hz, or 2 kHz, selectable. |

Normal mode

Normal mode is optimized for maximum update rate (throughput). If the fast control port (FCP) Option CC1 or CC3 is installed, it provides the capability to use pulse descriptor words (PDWs) to control frequency, amplitude, phase, pulse (include chirp or phase coding), and FM or Φ M. The PDW is streamed into the rear-panel FCP 100-pin connector using 46-bit wide control words. The control word information is executed synchronously upon receipt of a trigger.

Fast CW mode

Fast CW mode is optimized for minimum latency. The FCP control over signal attributes is limited to CW frequency switching and the addition of FM/ Φ M provided this option was purchased. It is typically used with the FCP Option CC2 for compatibility with instruments used in legacy test systems.

PDW Streaming mode

Streaming provides agile control of most of the instrument settings via a continuous stream of PDWs transferred from the internal SSD or an external source, such as a LAN or the Fast Control Port. The set of parameters controlled by Streaming include frequency, frequency band map, band adjust, relative power, phase, phase mode, pulse width, pulse start time, FM (chirp) and PM (phase coding). Each PDW consists of seven 32-bit words. The streaming PDW parameters are executed asynchronously, based on the time stamp information contained within the PDW.

| From file on solid state drive (SSD) | |
|---|---|
| PDW streaming rate | 750 k pulses/s (nom) |
| Over LAN port | |
| PDW streaming rate | 750 k pulses/s (nom) |
| Over fast control port (FCP) | |
| PDW streaming rate | 6 M pulses/s (nom) |
| Triggering | |
| PDW streaming trigger | Auto, external, single, SCPI, timer, or trigger key |
| PDW streaming trigger types | Play, abort, or cancel |
| Time accuracy | |
| Pulse start time accuracy/ resolution | 40 ps (typ)/10 ps |
| Pulse fine delay accuracy/ resolution | 40 ps (typ)/10 ps |

List mode

List mode lets you play out a list of PDW's located in and read from the instrument's FPGA memory. The memory contains a series of list points where each list point contains multiple signal attributes. This mode supports dynamic sequencing using the external trigger ports.

| Operating modes | |
|-------------------------|--|
| | List of frequency, phase, amplitude, pulse, chirp, and modulation parameters such as Barker codes. |
| Timing | |
| Uniform timer | |
| Standard | Advance every 100 μ s to 34 s |
| Option SS1 | Advance every 1 μ s to 34 s |
| Option SS4 | Advance every 48 ns to 34 s |
| Dwell timer | |
| Standard | Advance every 100 μ s to 17 s |
| Option SS1 | Advance every 1 μ s to 17 s |
| Option SS4 | Advance every 48 ns to 17 s |
| Number of points | |
| Arbitrary list | 1 to 500,000 per table assuming 50 sequences. Lists and sequences share the same memory. |

Triggering

| | |
|------------------|---|
| Point trigger | Auto, external, single, SCPI, timer, or trigger key |
| List trigger | Auto, external, single, SCPI, timer, or trigger key |
| Sequence trigger | Auto, external, single, SCPI, timer, or trigger key |

Markers

| | |
|--------------------------------|----------------------------|
| Marker types | List, sequence, point |
| Number of configurable markers | Up to 12, 8 simultaneously |
| Settable marker parameters | Polarity, delay |

Spectral purity**Harmonics**

Measured at +10 dBm or maximum specified power, whichever is lower. Performance is unspecified for harmonics beyond the specified frequency range.

| Fundamental frequency | Harmonic level |
|---------------------------------------|----------------|
| 10 MHz to 2.61 GHz (Frequency Mode B) | -25 dBc (typ) |
| 10 MHz to 1 GHz (Frequency Mode A) | -40 dBc |
| > 1 GHz to 2 GHz (Frequency Mode A) | -50 dBc |
| > 2 GHz (Frequency Mode A and B) | -55 dBc |

Sub-harmonics

Measured at +10 dBm or maximum specified power, whichever is lower. Sub-harmonics are defined as Carrier Freq $\times (x/N)$, where N indicates the frequency multiplication number and X is an integer value that is not an integer multiple of N. Does not apply to non-harmonic spurs which may overlap with sub-harmonics. Performance is unspecified for sub-harmonics beyond the specified frequency range.

| Fundamental frequency | 1/2, 3/4, and 3/2 sub-harmonics | Other sub-harmonics | N |
|------------------------------|---------------------------------|---------------------|----|
| 0.01 to < 1.43 GHz | None | None | 1 |
| 1.43 to < 2.85 GHz | -75 dBc | -80 dBc | 2 |
| 2.85 to < 5.7 GHz | -75 dBc | -80 dBc | 4 |
| 5.7 to < 11.4 GHz | -75 dBc | -80 dBc | 8 |
| 11.4 to < 16 GHz | -70 dBc | -80 dBc | 16 |
| 16 to 20 GHz | -65 dBc (typ) | -70 dBc (typ) | 16 |
| > 20 to < 22.8 GHz (Opt 540) | -70 dBc (typ) | -70 dBc (typ) | 16 |
| 22.8 to 38 GHz (Opt 540) | -70 dBc (typ) | -70 dBc (typ) | 32 |
| > 38 to 40 GHz (Opt 540) | -62 dBc (typ) | -70 dBc (typ) | 32 |

Non-harmonics

Measured in Frequency Mode A at +10 dBm or maximum specified power, whichever is lower. Performance is unspecified for non-harmonics beyond the specified frequency range.

| Fundamental frequency | Offsets > 300 Hz excluding Power-line related | Power-line related |
|---------------------------------|--|--------------------|
| 0.01 to < 1.43 GHz | -70 dBc (typ) | -60 dBc (typ) |
| 1.43 to < 2.85 GHz | -70 dBc (typ) | -60 dBc (typ) |
| 2.85 to < 5.7 GHz | -70 dBc (typ) | -50 dBc (typ) |
| 5.7 to < 11.4 GHz | -70 dBc (typ) | -50 dBc (typ) |
| 11.4 GHz to 20 GHz | -70 dBc (typ) | -50 dBc (typ) |
| > 20 GHz (Opt 540) ¹ | -65 dBc (typ) | -45 dBc (typ) |

Broadband noise

In CW mode at +10 dBm or maximum specified output power, whichever is lower, for offsets > 10 MHz.

| Frequency | Broadband noise |
|------------------------------|-------------------|
| 10 MHz to 20 GHz | -131 dBc/Hz (typ) |
| > 20 GHz to 40 GHz (Opt 540) | -125 dBc/Hz (typ) |

1. At precisely 22 GHz, several spurs coalesce and may add to -60 dBc. Moving 1 Hz away from 22 GHz avoids this issue.

Phase noise

Phase noise is measured using a CW signal at +10 dBm or maximum specified power, whichever is less, with spur optimizations off. Phase noise specifications exclude external mechanical vibration.

| Absolute SSB phase noise (dBc/Hz) | |
|-----------------------------------|----------------------|
| Frequency | Offset from carrier |
| | 20 kHz spec (typ) |
| 0.01 to < 1.43 GHz | -132 (-135) |
| 1.43 to < 2.85 GHz | -125 (-129) |
| 2.85 to < 5.7 GHz | -119 (-122) |
| 5.7 to < 11.4 GHz | -114 (-117) |
| 11.4 to 20 GHz | -109 (-112) |
| > 20 GHz (Opt 540) | -103 (-106) |

| Option EP1: Absolute SSB phase noise (dBc/Hz) for offsets \leq 100 kHz | | | | | | |
|--|---------------------|---------------------|----------------------|---------------------|----------------------|-----------------------|
| Frequency | Offset from carrier | | | | | |
| | 1 Hz spec (typ) | 10 Hz spec (typ) | 100 Hz spec (typ) | 1 kHz spec (typ) | 10 kHz spec (typ) | 100 kHz spec (typ) |
| 0.01 to < 1.43 GHz | -59 (-68) | -79 (-93) | -95 (-109) | -121 (-134) | -137 (-144) | -139 (-147) |
| 1.43 to < 2.85 GHz | -53 (-63) | -76 (-86) | -88 (-101) | -114 (-127) | -129 (-136) | -134 (-141) |
| 2.85 to < 5.7 GHz | -43 (-53) | -69 (-79) | -84 (-97) | -108 (-122) | -128 (-132) | -128 (-135) |
| 5.7 to < 11.4 GHz | -37 (-49) | -63 (-73) | -78 (-90) | -101 (-114) | -121 (-126) | -122 (-130) |
| 11.4 to 20 GHz | -33 (-44) | -58 (-68) | -69 (-84) | -96 (-110) | -114 (-120) | -117 (-125) |
| > 20 GHz (Opt 540) | -27 (-38) | -52 (-62) | -63 (-78) | -90 (-104) | -108 (-114) | -111 (-119) |

| Option EP1: Absolute SSB phase noise (dBc/Hz) for offsets \geq 1 MHz | | | |
|--|---------------------|----------------------|-----------------------|
| Frequency | Offset from carrier | | |
| | 1 MHz spec (typ) | 10 MHz spec (typ) | 100 MHz spec (typ) |
| 10 to < 50 MHz | -145 (-151) | n/a | n/a |
| 50 to < 500 MHz | -145 (-151) | -144 (-151) | n/a |
| 0.5 to < 1.43 GHz | -145 (-151) | -144 (-151) | -137 (-147) |
| 1.43 to < 2.85 GHz | -141 (-147) | -144 (-151) | -139 (-147) |
| 2.85 to < 5.7 GHz | -137 (-143) | -139 (-145) | -134 (-142) |
| 5.7 to < 11.4 GHz | -131 (-137) | -131 (-139) | -129 (-137) |
| 11.4 to 20 GHz | -126 (-131) | -126 (-134) | -123 (-131) |
| > 20 GHz (Opt 540) | -120 (-125) | -120 (-128) | -117 (-125) |

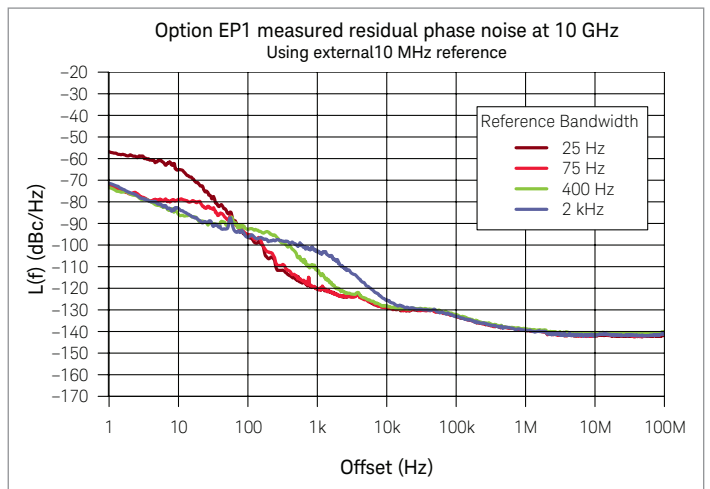
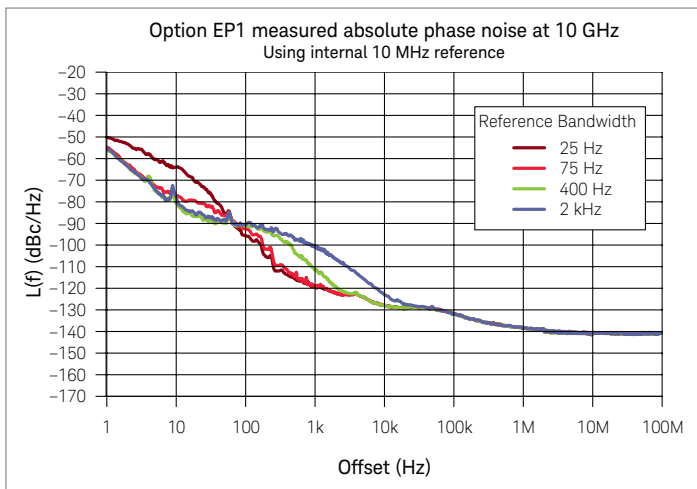
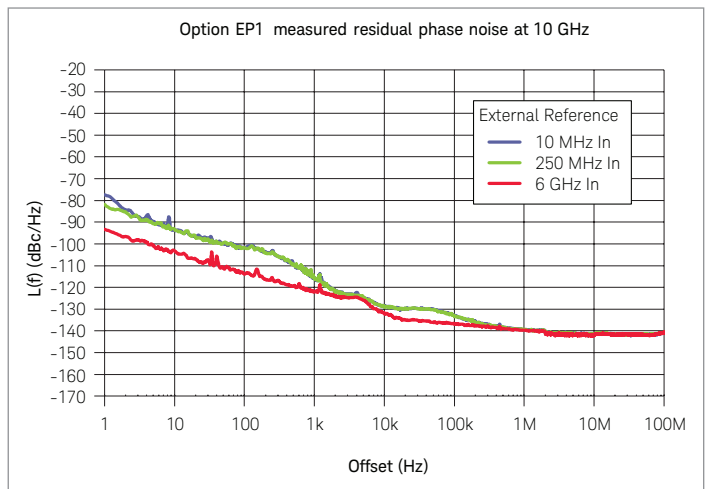
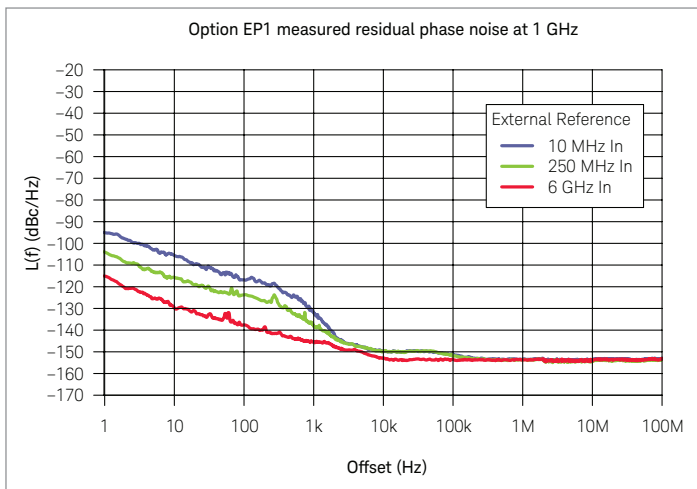
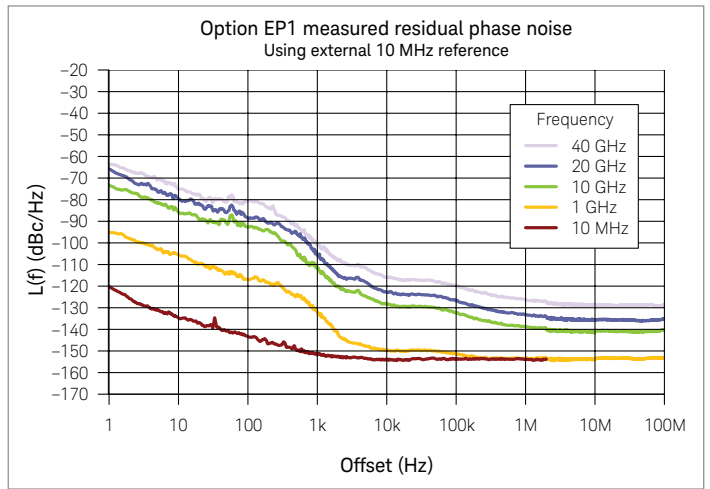
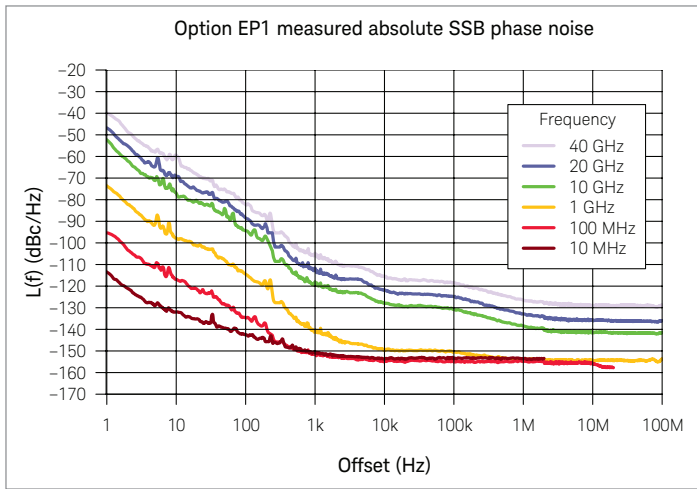

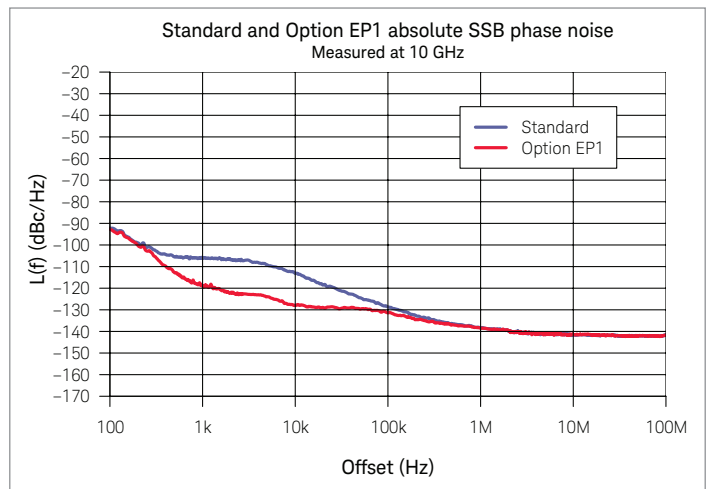
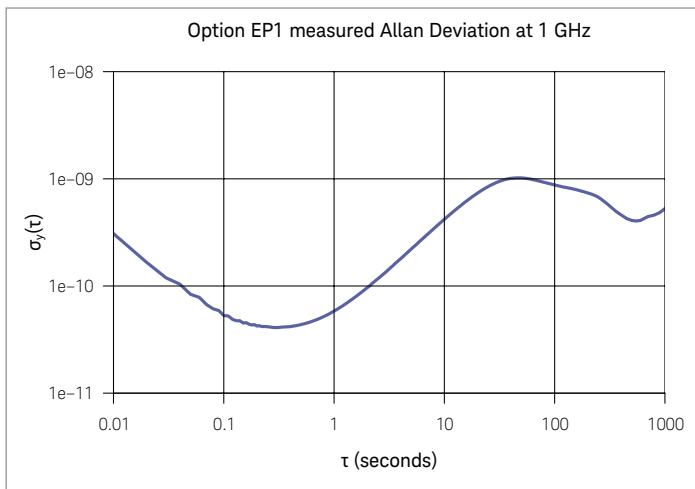
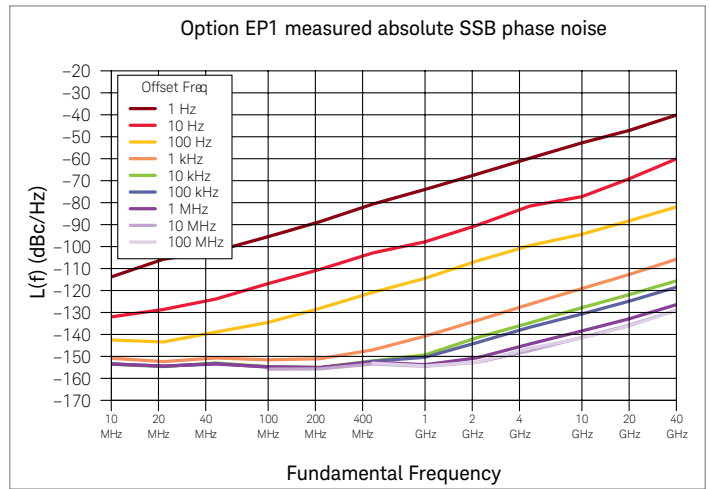
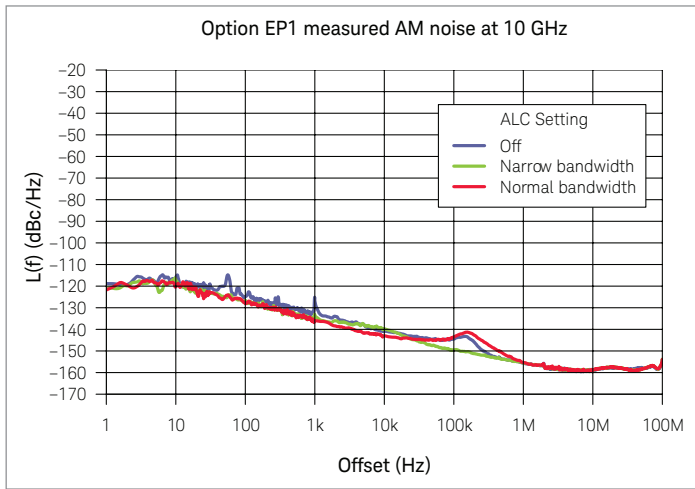

Pulse modulation (Option PM1)

For frequencies from 400 MHz to 1.43 GHz, pulse modulation specifications apply in Mode B only. For frequencies below 400 MHz, pulse modulation is not specified.

| Pulse types | |
|--|---|
| External input | The RF pulse width is the same as the input pulse width at the pulse/trigger gate input connector. |
| Triggered | The internal pulse generator is triggered by a selectable trigger source. The pulse delay and width are settable. |
| List mode | The pulse parameters are defined in a list. |
| Streaming mode | The pulse parameters are defined in the streamed PDW data. |
| Free run | The internal pulse generator generates pulses with the specified parameters without waiting for a trigger. |
| On/off ratio | |
| 0.4 to < 4.2 GHz | 80 dB (90 dB typ) |
| 4.2 GHz to 20 GHz | 90 dB |
| > 20 GHz (Option 540) | 80 dB (90 dB typ) |
| Rise/fall times | |
| 0.4 to < 1.43 GHz | (6 ns typ) |
| 1.43 to < 2.85 GHz | 10 ns (6 ns typ) |
| ≥ 2.85 GHz | 10 ns (3 ns typ) |
| Minimum pulse width | |
| ALC on | 50 ns |
| ALC off | 10 ns |
| Minimum pulse repetition interval | |
| ALC on | 60 ns |
| ALC off | 20 ns |

Time accuracy

| | |
|---------------------------------------|-------------------|
| Pulse start time accuracy/ resolution | 40 ps (typ)/10 ps |
| Pulse fine delay accuracy/ resolution | 40 ps (typ)/10 ps |

Level accuracy (relative to CW)

For pulse width ≥ 100 ns with ALC on and for pulse width ≥ 10 ns with ALC off.

| | |
|-------------------|------------------|
| 0.4 to < 1.43 GHz | ± 1 dB (typ) |
| ≥ 1.43 GHz | ± 1 dB (typ) |

Width compression

| | |
|--------------------------------|------------------|
| RF width relative to video out | ± 5 ns (typ) |
|--------------------------------|------------------|

Video feed-through

| | |
|---|-----------|
| For frequencies ≥ 400 MHz and output power of 10 dBm or less | 10% (typ) |
|---|-----------|

Video delay

| | |
|--------------------------------|--------------|
| External input to video output | 60 ns (meas) |
|--------------------------------|--------------|

RF delay (video to RF output)

| | |
|---------------------|--------------|
| Frequency > 500 MHz | 10 ns (meas) |
|---------------------|--------------|

Pulse overshoot

| |
|-----------|
| 10% (typ) |
|-----------|

Input level

| |
|--------------|
| +1 V = RF on |
| 0 V = RF off |

Input impedance

| |
|-------------------|
| 50 Ω (nom) |
|-------------------|

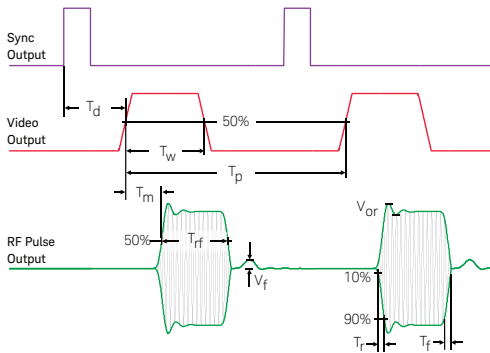

Measured pulse shape

Frequency = 9 GHz, power = 10 dBm, amplitude = 10 dBm, ALC off, pulse width = 10 ns, pulse period = 100 ns. The oscilloscope is protected by a 10 dB pad and the timescale is set to 2 ns/div.

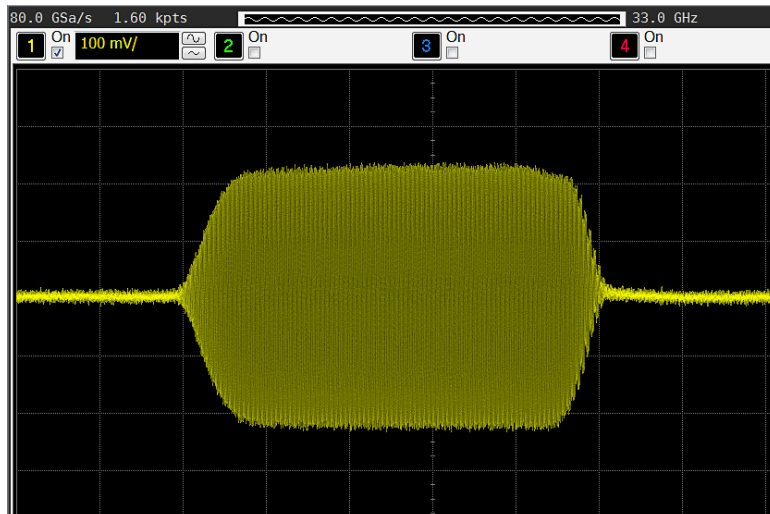

Chirp and chirped-pulse modulation (Options UNT, WC1, and PM1)

Option WC1 is required for chirp control through the Option CC1 I/O interface.

| Options installed | FCP in normal mode | | Streaming mode | Fast CW mode | List mode |
|-------------------|--|---------------------------------|-----------------------------|-----------------------------|--------------------|
| | Opt CC1 (LVDS) or Opt CC3 (10 Gbit Ethernet) | Opt CC2 (BCD) | | | |
| FMCW Chirp | | | | | |
| UNT | FMCW: 32 chirp slope selections | FMCW: 16 chirp slope selections | FMCW not available | FMCW not available | FMCW not available |
| UNT + WC1 | FMCW | FMCW: 16 chirp slope selections | FMCW | FMCW not available | FMCW |
| Pulse Chirp | | | | | |
| UNT + PM1 | 32 chirp slope selections within pulse | Chirped pulse not available | Chirped pulse not available | Chirped pulse not available | LFM within pulse |
| UNT + WC1 + PM1 | LFM within pulse | Chirped pulse not available | LFM within pulse | Chirped pulse not available | LFM within pulse |

Note: CW chirp (opt UNT required) and Pulse Chirp (opt PM1 required) are available under the Pulse/Chirp hardkey in all modes except Fast CW mode.

Pulse types

| | |
|---------------------------|-----------------------------------|
| Compatible without jitter | Free-run, synchronously triggered |
| With ± 8 ns jitter | Asynchronously triggered |
| Incompatible | External pulse |

Pulse and chirp alignment

Chirp start time is aligned to pulse start time within ± 50 ns (typ)

Deviation (peak to peak) with Option UNT

Option 520 cannot chirp beyond 21.5 GHz. Option 540 cannot chirp beyond 40 GHz.

| Frequency | Maximum peak to peak deviation |
|-------------------------------------|--------------------------------|
| 10 MHz to < 250 MHz | 8 MHz |
| 250 MHz to < 8 GHz | 256 MHz |
| 8 GHz to < 12 GHz | 384 MHz |
| 12 GHz to < 18 GHz | 512 MHz |
| 18 GHz to 20 GHz | 768 MHz |
| > 20 GHz to < 26.5 GHz (Option 540) | 768 MHz |
| ≥ 26.5 GHz (Option 540) | 1024 MHz |

Deviation (peak to peak) with Options UNT and WC1

Option 520 cannot chirp beyond 21.5 GHz. Option 540 cannot chirp beyond 40 GHz.

| Frequency | Maximum peak to peak deviation |
|-----------------------|--------------------------------|
| 50 MHz to 20 GHz | 10% of center frequency |
| > 20 GHz (Option 540) | 1.2 GHz |

Wider deviations are available when not near a band edge, for example, any chirp which lies within one band is obtainable. See the frequency band diagrams. Amplitude accuracy may degrade for wide chirps.

Rate

| | |
|------------|---|
| Range | 10 kHz/ μ s to 1.3 GHz/ns |
| Resolution | 10 kHz/ μ s to 0.32768 kHz/ns depending on rate |

Internal pulse generator (Option PM1)

| Internal pulse generator | |
|--------------------------|--|
| Modes | Free-run, square, and triggered |
| Square wave rate | 0.1 Hz to 10 MHz with 0.1 Hz resolution (nom) |
| Pulse period (PRI) (Tp) | 30 ns to 42 s, corresponding to repetition frequencies of 0.024 Hz to 33.33 MHz. |
| Minimum pulse width (Tw) | 4 ns (nom) |
| Pulse accuracy | 40 ps (typ) |
| Delay resolution | 10 ps |
| PRI resolution | 2 ns |
| Width resolution | 2 ns |

Frequency modulation (Option UNT)

| Maximum rate | |
|----------------------|--------|
| Internal or external | 10 MHz |

| Maximum peak deviation with Option UNT | |
|---|--|
| Option 520 cannot deviate beyond 21.5 GHz. Option 540 cannot deviate beyond 40 GHz. | |

| Frequency | Maximum peak deviation |
|-------------------------------------|------------------------|
| 10 MHz to < 250 MHz | 4 MHz |
| 250 MHz to < 8 GHz | 128 MHz |
| 8 GHz to < 12 GHz | 192 MHz |
| 12 GHz to < 18 GHz | 256 MHz |
| 18 GHz to 20 GHz | 384 MHz |
| > 20 GHz to < 26.5 GHz (Option 540) | 384 MHz |
| ≥ 26.5 GHz (Option 540) | 512 MHz |

| Maximum peak deviation with Options UNT and WC1 | |
|---|--|
| Option 520 cannot deviate beyond 21.5 GHz. Option 540 cannot deviate beyond 40 GHz. | |

| Frequency | Maximum peak deviation |
|-----------------------|------------------------|
| 10 MHz to 20 GHz | 5% of center frequency |
| > 20 GHz (Option 540) | 600 MHz |

Wider deviations are available when not near a band edge, for example, any FM deviation which lies within one band is obtainable. See the frequency band diagrams. Amplitude accuracy may degrade for wide FM.

| Resolution | |
|------------|---|
| | 0.1% of deviation or 1 Hz, whichever is greater |

| Deviation accuracy | |
|--|--|
| Measured at a 1 kHz rate with 100 kHz deviation. | |

| | |
|-------------|-----------------------------------|
| Internal | ± 1% of FM deviation (± 0.2% typ) |
| External In | ± 3.5% of FM deviation + 20 Hz |

| Modulation frequency response (3 dB bandwidth) | |
|--|--|
| Measured at 100 kHz deviation. | |

| | |
|-------------|----------------------|
| DC coupling | DC to 10 MHz (nom) |
| AC coupling | 5 Hz to 10 MHz (nom) |

| External DC FM carrier offset | |
|--|--|
| At the calibrated deviation and carrier frequency, within 5 °C of ambient temperature at time of user calibration. | |

| | |
|--|--------------------------------|
| | ± 0.1% of set deviation (meas) |
|--|--------------------------------|

| Distortion | |
|--|--|
| Measured at a 1 kHz rate with 100 kHz deviation. | |

| | |
|--|------|
| | 0.4% |
|--|------|

| Sensitivity | |
|-------------|---|
| | ± 1 V _{peak} for indicated deviation |

| Frequency coding (FSK) | |
|------------------------|-----------------------------|
| Number of levels | 16 levels, at least 32 maps |
| Minimum bin width | 4 ns |
| Maximum pattern length | 65,536 bits/pattern |

Phase modulation (Option UNT)

| | |
|--|---|
| Maximum rate | |
| Internal or external | 10 MHz |
| Maximum peak deviation in radians | |
| $\frac{5\% \text{ of carrier frequency}}{\text{modulation frequency}}$ or $\frac{600 \text{ MHz}}{\text{modulation frequency}}$ or 12π whichever is less | |
| Resolution | |
| | 0.1% of set deviation |
| Deviation accuracy | |
| Measured at a 1 kHz rate with 3π rad deviation. | |
| Internal | $\pm 1\%$ of ΦM deviation ($\pm 0.2\%$ typ) |
| External In | $\pm 3.5\%$ of ΦM deviation |
| Modulation frequency response (3 dB bandwidth) | |
| Measured at 3π rad deviation. | |
| DC coupling | DC to 10 MHz (nom) |
| AC coupling | 5 Hz to 10 MHz (nom) |
| Distortion | |
| Measured at a 1 kHz rate with 3π rad deviation. | |
| Total harmonic distortion | 0.5% (0.1% typ) |
| Sensitivity | |
| | $\pm 1 V_{\text{peak}}$ for indicated deviation |
| Phase modulation types | |
| Triggered BPSK | Phase can be changed 180° on a bin-by-bin basis every 8 ns via an external trigger |
| Barker coding | |
| Supported codes | 2, 3, 4, 5, 7, 11, 13 |
| Phase coding (PSK) | |
| Number of levels | 16 levels, at least 32 maps |
| Minimum bin width/resolution | 4 ns / 4 ns |
| Maximum pattern length | 65,536 bits/pattern |

Amplitude modulation (Option UNT)

AM performance is typical up to 20 GHz with ALC on when AM peaks do not exceed maximum specified power. AM performance is not specified with ALC off or above 20 GHz or when AM peaks exceed maximum specified power.

| | |
|---|--------------------------------------|
| Maximum depth | |
| | 80% (14 dB) |
| Depth accuracy | |
| ALC on, 1 kHz rate and depth $\leq 80\%$ | $\pm (6\% \text{ of setting} + 1\%)$ |
| External input (selectable polarity) | |
| Sensitivity for indicated depth | $1 V_{\text{peak}}$ |
| Maximum voltage | $\pm 1 \text{ V}$ |
| Modulation frequency response (3 dB bandwidth) | |
| Measured at 30% depth. | |
| DC coupling | DC to 10 MHz (nom) |
| AC coupling | 5 Hz to 10 MHz (nom) |
| Distortion | |
| 30% AM, 1 kHz rate | 1.5% total harmonic distortion |
| 60% AM, 1 kHz rate | 2% total harmonic distortion |

External modulation inputs (Option UNT)

| | |
|------------------|---|
| Connections | Ext1 and Ext2 |
| Modulation types | AM, FM, and ΦM |
| Input impedance | 50 Ω , 600 Ω , or 1 M Ω (nom) switched |

Internal modulation source (Option UNT)

| | |
|--------------------------|---|
| Dual function generators | Provide two independent signals (internal1 and internal2) for use with AM, FM, Φ M, or LF output. |
| Waveforms | Sine, square, positive ramp, negative ramp, triangle, pulse, uniform noise, Gaussian noise. |
| Rate range | |
| Sine | 0.1 Hz to 10 MHz |
| Square, ramp, triangle | 0.1 Hz to 1 MHz |
| Resolution | 0.1 Hz |
| Accuracy | Same as timebase |
| LF output | |
| Output | Internal 1, internal 2, noise generator 1, noise generator 2. Also provides monitoring of function generators when used for AM, FM, or Φ M. |
| Amplitude | 0 to 5 V _{peak} (nom) into 50 Ω or 10 V (nom) into 1 M Ω |
| Output impedance | 50 Ω (nom) |

Simultaneous modulation

Simultaneous modulation

All modulation types (FM, AM, Φ M, chirp, and pulse modulation) may be simultaneously enabled except FM with Φ M.

AM, FM, and Φ M can sum simultaneous inputs from any two sources (Ext1, Ext2, internal1, or internal2).

Any given source (Ext1, Ext2, internal1, or internal2) may be routed to only one activated modulation type.

Remote programming

| | |
|-----------------------|---|
| Interfaces | GPIB (IEEE-488.2,1987) with listen and talk, USB 2.0, and 1000BaseT LAN interface. |
| Control languages | SCPI version 1997.0. Code compatibility modes for Aeroflex 2500, 2200, FS2000 or FS5000. |
| IEEE-488 functions | SH1, AH1, T6, TEO, L4, LEO, SR1, RL1, PPO, DC1, DTO, CO, E2 |
| Keysight IO libraries | Keysight's IO Library Suite helps you quickly establish an error-free connection between your PC and instruments, regardless of the vendor. It provides robust instrument control and works with the software development environment you choose. |

General specifications

| | |
|-----------------------------|---|
| Power requirements | 100/120 VAC 50/60/400 Hz or 220/240 VAC 50/60 Hz (automatically selected) < 350 W typical, 400 W maximum |
| Operating temperature range | 0 to 55 °C |
| Storage temperature range | -40 to 70 °C; during storage below -20 °C, instrument states may be lost. |
| Altitude | 0 to 4600 m (15,000 ft) |
| Humidity | Relative humidity - type tested at 95%, +40 °C (non-condensing). |
| Environmental testing | Samples of this product have been tested in accordance with the Keysight Environmental Test Manual and verified to be robust against the environmental stresses of storage, transportation, and end-use. Those stresses include but are not limited to temperature, humidity, shock, vibration, altitude, and power line conditions. Test methods are aligned with IEC 60068-2 and levels are similar to MIL-PRF-28800F Class 3. Phase noise specifications are not warranted in a vibrating environment. |
| ISO compliant | This family of signal generators is manufactured in an ISO-9001 registered facility in concurrence with Keysight's commitment to quality. |
| EMC | Conforms to the immunity and emission requirements of IEC/EN 61326-1 including the conducted and radiated emission requirements of CISPR Pub 11/2009 Group 1, Class A. |
| Acoustic noise | Normal: 48 dBA (nom) Worst case: 68 dBA (nom) |
| Storage | Memory is shared by instrument states and sweep list files. The solid-state drive initially has at least 480 GB of free space ¹ . |

1. Instruments with s/n < 53310101 (shipped prior to July 30, 2015) have 80 GB capacity.

| | |
|-------------------------------|---|
| Security | Display blanking Memory clearing functions (See Application Note, "Security Features of Keysight Technologies Signal Generators," Part Number E4400-90621). Removable Solid State Drive (SSD) with all user data. |
| Self-test | Internal diagnostic routine tests most modules in a preset condition. If node voltages are within acceptable limits, then the module passes the test. |
| Weight | < 25 kg (54 lb.) net < 34 kg (73 lb.) shipping |
| Dimensions | 134 mm H x 426 mm W x 559 mm D (5.25" H x 16.8" W x 22.0" D) |
| Recommended calibration cycle | 12 months |

Input/Output Descriptions

Front panel connectors

Unless otherwise noted, all connectors are BNC female, digital inputs and outputs are 3.3 V CMOS, and digital inputs will accept 5 V CMOS, 3 V CMOS, or TTL voltage levels. Option 1EM moves all connectors to the rear panel except the USB connectors.

| | |
|--------------------------|--|
| RF output | Output impedance 50 Ω (nom). |
| Option 520 | Standard: Precision APC-3.5 male; plus 3.5 - 3.5 mm female adapter Option 1ED: Type-N female; plus Type-N male to SMA female adapter |
| Option 540 | Precision 2.4 mm male; plus 2.4 - 2.4 mm and 2.4 - 2.9 mm female adapters. |
| USB 2.0 master (2 ports) | Allows control of USB devices. USB Type-A female connector. Nominal output current 0.5 A. |
| LF output | Outputs the internally generated LF source. Nominal output impedance 50 Ω . |
| External input 1 | Drives either AM, FM, or Φ M. Nominal input impedance is 50 Ω , 600 Ω , or 1 M Ω , selectable. Damage levels are 5 V _{rms} and 10 V _{peak} . |
| External input 2 | Drives either AM, FM, or Φ M. Nominal input impedance is 50 Ω , 600 Ω , or 1 M Ω , selectable. Damage levels are 5 V _{rms} and 10 V _{peak} . |
| Pulse/trigger gate input | Accepts input signal for external pulse modulation. Also accepts external trigger pulse input for internal pulse modulation. Nominal impedance 50 Ω . Damage levels are 5 V _{rms} and 10 V _{peak} . |
| Pulse video out | Outputs a signal that follows the RF output for internal pulse modes. TTL-level compatible. Nominal source impedance 50 Ω . |
| Pulse sync out | Outputs a synchronizing pulse, nominally 50 ns width, for internal pulse modes. TTL-level compatible, nominal source impedance 50 Ω . |

Rear panel connectors

Unless otherwise noted, all connectors are BNC female, digital inputs and outputs are 3.3 V CMOS, and digital inputs will accept 5 V CMOS, 3 V CMOS, or TTL voltage levels. Option 1EM moves the front panel connectors to the rear panel except the USB connectors.

| | |
|--------------------------|---|
| GPIB | Operates as a GPIB controller or device. IEEE-488 bus connector. |
| LAN (1000 BaseT) | Allows LAN TCP/IP communication. RJ45 Ethernet connector. The LAN connector provides the same SCPI remote programming functionality as the GPIB connector. The LAN connector is used to access the internal web server and FTP server. The LAN supports DHCP, HiSLIP, sockets SCPI, VXI-11 SCPI, connection monitoring, dynamic hostname services, and TCP keep alive. This interface is LXI class C compliant. |
| USB 2.0 master (2 ports) | Allows control of USB devices. USB Type-A female connector. Nominal output current 0.5 A. |
| USB 2.0 slave (1 port) | Receives control from USB host. USB Type-B female connector. Nominal output current 0.5 A. |
| PCIe x8 | Provides 8 lanes of PCIe I/O. Reserved for future use. |
| 10 MHz input | Accepts a 10 MHz external reference (timebase) input. Nominal input impedance 50 Ω . Nominal input range 0 to 12 dBm. |
| 10/100 MHz output | Provides a reference signal of 10 MHz or 100 MHz, selectable. Nominal output impedance 50 Ω . Nominal output power 7 dBm. Suitable for use with the 10 MHz input or System Sync input of another compatible signal generator. |
| 10 MHz EFC | Accepts an external DC voltage, ranging from -10 V to +10 V, for electronic frequency control (EFC) of the internal 10 MHz reference oscillator. This voltage inversely tunes the oscillator about its center frequency. See the EFC sensitivity in the frequency section. The nominal input impedance is greater than 1 M Ω . |

| | |
|-------------------|---|
| System sync input | Accepts an external reference input. The acceptable frequencies are listed in the synchronization section. Nominal input impedance 50 Ω , with a DC block. Nominal input range 0 to 12 dBm. |
| RF sync output | Provides an external reference output of 10, 100, or 250 MHz, or Sync Output, selectable. Nominal output impedance 50 Ω . Nominal output power 12 dBm. Suitable for use with the System sync input. This output is a square wave with a fast rise time. To avoid electromagnetic interference, use coaxial cable with at least 90 dB shielding effectiveness. Example: Times Microwave Systems LMR 240 coaxial cable used in Amphenol PN 115101-22-48.00 BNC cable assembly. |
| 6 GHz input | SMA female connector. Accepts a synchronization input of 6 GHz. Nominal input impedance 50 Ω . Nominal input range 5 to 17 dBm. Damage levels are above +23 dBm. |
| 6 GHz output | SMA female connector. Provides a synchronization output of 6 GHz. Nominal output impedance 50 Ω . Nominal output power 17 dBm. Suitable for use with the 6 GHz input. |

Fast Control Port (FCP) interface modules

On the trigger and marker connectors, digital inputs and outputs are 3.3 V CMOS, and digital inputs will accept 5 V CMOS, 3 V CMOS, or TTL voltage levels.

| Option CC1 I/O interface | |
|---------------------------------|--|
| Data port | 100 pin LVDS |
| Triggers and markers | 2 SMA and 12 SMB |
| Data format | Binary |
| Controllable parameters | Frequency, amplitude, phase, phase coding, band, pulse, chirp, FM deviation, Φ M deviation, depending on installed options. |
| Option CC2 I/O interface | |
| Data connector | 50 pin |
| Triggers and markers | 2 SMA |
| Data format | Binary coded decimal (BCD) |
| Controllable parameters | Frequency, FM deviation, or 16 Chirp rates |
| Option CC3 I/O interface | |
| Data ports | 2 SFP+ transceivers |
| Triggers and markers | 2 SMA and 1 SMB |
| Data format | Keysight data streaming protocol |
| Controllable parameters | Frequency, amplitude, phase, phase coding, band, pulse, chirp, FM deviation, Φ M deviation, depending on installed options. |

Performance Archive

From time to time, Keysight Technologies may make changes to instrument performance. Details on the specifications and performance differences of earlier versions summarized below can be found in the N5193A data sheet archive found in the UXG online documentation at <http://www.keysight.com/main/editorial.jsp?cc=US&lc=eng&ckey=2550695&nid=-32491.1150339.00&id=2550695>.

Solid state drive (SSD) capacity was increased from 80 GB to 480 GB on instruments with s/n \geq 53310101, shipped after July 30, 2015.

Option AT2 replaced the previous attenuator option AT1 on instruments with s/n \geq 5646xxxx. Option AT2 offers improved performance in the 25.6 to 40 GHz range. Option AT1 performance specifications can be found on pages 7-10 in the N5193A data sheet dated June 8, 2016.

Option SS4 replaced the previous switching speed option SS2 on instruments with s/n \geq 5646xxxx. Option SS4 offers improved performance for Type 4 frequency transitions. Option SS2 performance specifications can be found on page 11 in the N5193A data sheet dated June 8, 2016.

Related Literature

UXG Brochure, 5992-0091EN

UXG Configuration Guide, 5992-0093EN

Evolving

Our unique combination of hardware, software, support, and people can help you reach your next breakthrough. We are unlocking the future of technology.



From Hewlett-Packard to Agilent to Keysight



myKeysight

myKeysight
www.keysight.com/find/mykeysight

A personalized view into the information most relevant to you.

KEYSIGHT SERVICES

Accelerate Technology Adoption.
 Lower costs.

Keysight Services
www.keysight.com/find/service

Our deep offering in design, test, and measurement services deploys an industry-leading array of people, processes, and tools. The result? We help you implement new technologies and engineer improved processes that lower costs.



Three-Year Warranty
www.keysight.com/find/ThreeYearWarranty

Keysight's committed to superior product quality and lower total cost of ownership. Keysight is the only test and measurement company with three-year warranty standard on all instruments, worldwide. And, we provide a one-year warranty on many accessories, calibration devices, systems and custom products.



Keysight Assurance Plans
www.keysight.com/find/AssurancePlans

Up to ten years of protection and no budgetary surprises to ensure your instruments are operating to specification, so you can rely on accurate measurements.

Keysight Channel Partners
www.keysight.com/find/channelpartners

Get the best of both worlds: Keysight's measurement expertise and product breadth, combined with channel partner convenience.

www.keysight.com/find/uxg

For more information on Keysight Technologies' products, applications or services, please contact your local Keysight office. The complete list is available at:
www.keysight.com/find/contactus

Americas

| | |
|---------------|------------------|
| Canada | (877) 894 4414 |
| Brazil | 55 11 3351 7010 |
| Mexico | 001 800 254 2440 |
| United States | (800) 829 4444 |

Asia Pacific

| | |
|--------------------|----------------|
| Australia | 1 800 629 485 |
| China | 800 810 0189 |
| Hong Kong | 800 938 693 |
| India | 1 800 11 2626 |
| Japan | 0120 (421) 345 |
| Korea | 080 769 0800 |
| Malaysia | 1 800 888 848 |
| Singapore | 1 800 375 8100 |
| Taiwan | 0800 047 866 |
| Other AP Countries | (65) 6375 8100 |

Europe & Middle East

| | |
|----------------|---------------|
| Austria | 0800 001122 |
| Belgium | 0800 58580 |
| Finland | 0800 523252 |
| France | 0805 980333 |
| Germany | 0800 6270999 |
| Ireland | 1800 832700 |
| Israel | 1 809 343051 |
| Italy | 800 599100 |
| Luxembourg | +32 800 58580 |
| Netherlands | 0800 0233200 |
| Russia | 8800 5009286 |
| Spain | 800 000154 |
| Sweden | 0200 882255 |
| Switzerland | 0800 805353 |
| | Opt. 1 (DE) |
| | Opt. 2 (FR) |
| | Opt. 3 (IT) |
| United Kingdom | 0800 0260637 |

For other unlisted countries:
www.keysight.com/find/contactus
 (BP-10-3-16)



www.keysight.com/go/quality
 Keysight Technologies, Inc.
 DEKRA Certified ISO 9001:2015
 Quality Management System